



FRIEDRICH-SCHILLER-
UNIVERSITÄT
JENA

Comprehensive Patent Data of the German Democratic Republic 1949- 1990—technical report and dataset overview

Ann Hipp | Michael Fritsch | Maria Greve | Jutta Gün-
ther | Marcel Lange | Christian Liutik | Beate Pfeifer |
Mariia Shkolnykova | Michael Wyrwich

JENA ECONOMIC RESEARCH PAPERS · # 2022-011

Comprehensive Patent Data of the German Democratic Republic 1949-1990—technical report and dataset overview

Ann Hipp^a, Michael Fritsch^b, Maria Greve^{b, c}, Jutta Günther^a, Marcel Lange^a,
Christian Liutik^b, Beate Pfeifer^b, Mariia Shkolnykova^a and Michael Wyrwich^{b, c}

September 2022

Abstract

This paper documents the generation and the content of the Comprehensive Patent Database (CPDB) of the German Democratic Republic (GDR) (1949-1990), Version 1.1, which is freely available at GESIS <https://doi.org/10.7802/2423>. The database contains all patents granted in the GDR and published by the Office of Inventions and Patents (AfEP, later: German Patent and Trade Mark Office/DPMA) in the period between 1 January 1939 (application before but granted in the GDR) and 29 June 2006 (application in but granted after the GDR). The core database covers the years 1950 to 1990 and contains 24 variables with manually cleaned and processed information on a total of 261,822 unique patents of the GDR. The data was collected and prepared for the purpose of research on innovation activity in the GDR.

Keywords: Patent data, German Democratic Republic (GDR), invention

JEL classification: O31, O33, P29, P39, B24

a) University of Bremen, Germany, b) Friedrich Schiller University Jena, Germany, c) University of Groningen, The Netherlands

1. Purpose

Patent data are a key source for analyzing innovation activity (Acs et al. 2002). Accordingly, patents play a key role in most studies of innovation and technological developments in the communist East German State, the German Democratic Republic (GDR), which existed from 1949 till 1990.¹ However, the patent data used in these studies are often rather incomplete², and it is unclear to what extent these data have been subject to plausibility checks and data cleaning.

In order to provide a solid empirical basis for further analyses of innovation activities in the GDR, we compiled a Comprehensive Patent Database (CPDB) as part of a collaborative research project funded by the Federal Ministry of Education and Research in Germany (2018-2023)³. The database is freely accessible at GESIS, Leibniz Institute for Social Sciences (<https://doi.org/10.7802/2423>). Compared to other sources of GDR patents, our database has three main advantages. First, it is much more comprehensive than any other available source.⁴ Second, erroneously detected data was manually verified and, if necessary, corrected or completed.⁵ Third, the data contains information that allows for a meaningful assignment of inventive activity to certain locations at the organizational level (for details, see Section 6).

We begin this technical report and overview with a brief description of the GDR patent system (Section 2) and then explain the informational content of

¹ For example, Bähr & Petzina (1996), Baar & Petzina (1999), Grupp et al. (2002), Glitz & Meyersson (2020).

² Glitz & Meyersson (2020) for example used aggregate data of the number of patent applications (not approved patents) at the level of combines (Kombinate) that is limited to the period 1970-1989.

³ Project title “Modernisierungsblockaden in Wirtschaft und Wissenschaft der DDR” (Obstacles to Modernization in the Economy and Science of the GDR) (project number 01UJ1806DY).

⁴ The recently published Patentcity data (Bergeaud & Verluise 2022) covers only slightly above half of the patents in our database. The coverage of Patentcity varies considerably between single years and sub-periods (see Figure A1 in the Appendix). Patentcity records considerably lower numbers of patents between the mid-1960s and the late 1970s. Moreover, in more than 80% of the observations, the Patentcity data does not contain the location of the inventor or of the applicant that was published in the years 1989 and 1990. If locations are included, they are quite often rather imprecise.

⁵ We found a number of typing errors and multiple counts in the original data. Moreover, there were some handwritten annotations on some patent documents that we included in the dataset if relevant. Quite frequently, some International Patent Classification (IPC) codes were added to the original patent ex-post, which we included in the data.

GDR patents (Section 3). Section 4 informs about the methods applied in gathering and preparing the data, and in Section 5 the data is described in some detail. Finally, we explain the generation of regional identifiers for 17,772 patents of the years 1989 and 1990 (Section 6).

2. Patenting in the GDR

After the foundation of the GDR, a patent law based on the Soviet-type model was established (Wiessner 2015). Based on the GDR Patent Act of 1950, the Office for Inventions and Patents (AfEP) in Berlin, subordinated to the Ministry of Planning, was responsible for all issues connected with patenting. The GDR joined the World Intellectual Property Organization (WIPO) in 1968, only one year after the WIPO's foundation. This ensured uniform international standards for filing patents—i.e., the degree of novelty, the inventive level, and the technical applicability (WIPO 1970). Despite the similarities in the dynamics of filing and granting patents, the comparability of the GDR patent data with those of the Federal Republic of Germany (FRG) remains highly controversial (see Fritsch et al. 2022; Günther et al. 2020; Grupp et al. 2005; Kogut & Zander 2000).

There were two types of patents in the GDR: the "exclusive patent" (*Ausschließungspatent*) and the "economic patent" (*Wirtschaftspatent*). The exclusive patent guaranteed the patent holder the right to exploit the invention and was very similar to the FRG patent. This type of patent was mainly effective for foreign applicants, especially from Western countries, who were granted exclusive rights for 18 years to use the registered invention in the GDR (Wiessner 2015). Figure 1 shows an example of an exclusive patent from the year 1972. The patent contains, among other things, the following information: identification number, file number, filing and publication date, name of inventor and owner, main bibliographic class, title, and description of the patent.

<p>Deutsche Demokratische Republik</p>  <p>Amt für Erfindungs- und Patentwesen</p>	<p>PATENTSCHRIFT 96101</p> <p>Ausschließungspatent</p> <p><small>Ereilt gemäß § 5 Absatz 1 des Änderungsgesetzes zum Patentgesetz</small></p> <hr/> <p>Zusatzpatent zum Patent: —</p> <p>Anmeldetag: 02.05.72 (AP F 16 c / 162 673)</p> <p>Priorität: 03.05.71 (P 21 21 816.6) DT</p> <p>Ausgabetag: 05.03.73</p>	<p>Int. Cl.: F 16 c, 33/80</p> <p>Kl.: 47 b, 33/80</p>
<p>In der vom Anmelder eingereichten Fassung veröffentlicht</p>		
<p>Erfinder: Schultenkämper, Dipl.-Ing. Josef, DT</p>		<p>Inhaber: Gelenkwellenbau GmbH, DT</p>
<p>Abdichtung für ein Wälzlager</p>		
<p>1</p> <p>Die Erfindung betrifft eine Abdichtung für ein Wälzlager, insbesondere für ein Zwischenwellenlager eines unterteilten Gelenkwellenstranges, mit je einer benachbart dem Wälzkörperkranz angeordneten Lippendichtung, einer nach außen abdichtenden Labyrinthdichtung und einer in den Zwischenraum zwischen der Lippendichtung und der Labyrinthdichtung eingebrachten Fettfüllung auf jeder Seite des Wälzkörperkranzes.</p> <p>Ein Zwischenwellenlager für einen unterteilten Gelenkwellenstrang, der zur Übertragung der Leistung eines vorn liegenden Antriebsmotors auf die Hinterräder des Fahrzeuges eingesetzt wird, soll heute in vielen Fällen völlig wartungsfrei gestaltet sein. Das Zwischenwellenlager soll also ohne jegliche Abschmierung über die ganze Lebensdauer des Gelenkwellenstranges laufen. Auch Wälzlager für andere Anwendungszwecke sollen heute häufig eine Lebensdauer-Abdichtung aufweisen.</p> <p>Es ist bereits eine Abdichtung mit den eingangs genannten Merkmalen für ein Zwischenwellenlager vorgesehen, bei der der Zwischenraum der Labyrinthdichtung und der Lippendichtung, deren Dichtlippe an der äußeren Umfangsfläche des Lagerinnenrings anliegt, ausschließlich mit Fett gefüllt ist und die Dichtkörper von parallelen Blechscheiben gebildet sind, die im wesentlichen und insbesondere mit ihren freien Enden radial ausgerichtet sind. Durch die Dichtspalten der Labyrinthdichtung und durch einen sich infolge von Zentrifugalwirkung bildenden Ringspalt an der radial inneren Seite der Fettfüllung kann bei der bekannten Abdichtung im Betrieb Staub und Wasser eindringen, wo-</p>	<p>2</p> <p>durch die Lagerlaufbahnen zerstört werden.</p> <p>Zur Vermeidung dieses Nachteils ist nach der Erfindung vorgesehen, daß benachbart jeder Seite des Lagerinnenrings eine Scheibe angeordnet ist, die radial nach außen in den mit Fett gefüllten Zwischenraum hineinragt.</p> <p>Durch die dem Lagerinnenring zugeordnete Scheibe wird die Fettfüllung bis auf einen zwischen der Scheibe und der Nabe bzw. dem inneren Dichtkörper der Labyrinthdichtung radial außen verbleibenden Spalt geteilt. Wenn daher im Betrieb infolge einer Zentrifugalwirkung das Fett nach außen gedrückt wird und radial innen ein Hohlraum entsteht, können evtl. in diesen Hohlraum eindringende Teilchen nicht bis zum Lager vordringen, sondern werden durch die dem Lagerinnenring zugeordnete Scheibe zurückgehalten. Da die Scheibe auch bei hoher Drehzahl radial außen stets von Fett umgeben ist, können Fremtteilchen die Scheibe radial nicht passieren. Die auf diese Weise verbesserte Abdichtung gewährleistet also einen absoluten Schutz vor dem Eindringen von Fremtteilchen über die gesamte Lebensdauer des Lagers.</p> <p>Eine zusätzliche Verbesserung des Lagers wird dadurch erzielt, daß jeder mit der Nabe feste, innere Dichtkörper der Labyrinthdichtung ein in eine Bohrung der Nabe eingeschobener Kunststoffring ist, der auf seiner nach außen weisenden Stirnfläche mit einer umlaufenden Aussparung versehen ist, und daß jeder äußere, mit der Welle umlaufende Dichtkörper an seinem radial äußeren Endbereich parallel der Aussparung verformt ist. Zweck-</p>	
<p>96 101 .</p>		

Figure 1: Example of an exclusive patent

The dominant type of GDR patent was the "economic patent", which was assigned to the respective inventor but did not grant him or her any exploitation rights for the invention; the right of use was instead transferred to the entire

economy of the GDR, and the usage was allowed after the responsible central authority had been notified. All inventors who successfully applied for a patent as employees of a state-owned enterprise (VEB), research institute, or other public institution received an economic patent, which recognized him or her as the intellectual source. In case that the patented invention generated economic benefits, the inventor received some remuneration (Wiessner 2015). The remuneration was based on the criteria of "benefit for the society", which were: 1) saving of current or initial expenses; 2) improvement of use characteristics and production of new products; 3) improvement of working and living conditions; 4) saving of jobs; 5) increase of production or services; 6) increase of exports, decrease of imports.⁶ Figure 2 shows an example of an economic patent, which has a similar structure as an exclusive patent.

⁶ These criteria were stipulated in the Regulation on the Determination of Benefits for the Remuneration of Innovations and Inventions of 20.7.1972 (*Anordnung über die Ermittlung des Nutzens zur Vergütung von Neuerungen und Erfindungen vom 20.7.1972, GBl. II Nr. 48 p. 550*) and the Regulation No. 2 on the Determination of Benefits for the Remuneration of Innovations and Inventions of 22.12.1983 (*Anordnung Nr. 2 über die Ermittlung des Nutzens zur Vergütung von Neuerungen und Erfindungen vom 22.12.1983, GBl. I Nr. 38 p. 432*).

<p>Deutsche Demokratische Republik</p>  <p>Amt für Erfindungs- und Patentwesen</p>	<h1>PATENTSCHRIFT 73 164</h1> <p>Wirtschaftspatent</p> <p><small>Ermittelt gemäß § 5 Absatz 1 des Änderungsgesetzes zum Patentgesetz</small></p>	<p>Kl.: 42 k, 46/04</p> <p>IPK.: G 01 n</p> <p>DK.:</p>
<p>Zusatzpatent zum Patent: -</p> <p>Anmeldetag: 13. VI. 1969 (WP 42k/140 502)</p> <p>Priorität: -</p> <p>Ausgabetag: 12. V. 1970</p>		
<p>Erfinder: Roland Schubert Peter Löbig Klaus Schuricht</p> <p>zugleich</p> <p>Inhaber: VEB Mechanisierung Karl-Marx-Stadt, Röhrsdorf/b. Karl-Marx-Stadt</p>		
<p>Prüfgerät zur Feststellung von Poren und Rissen in auf Gegenständen oder Bauwerken aus elektrisch leitendem oder halbleitendem Material aufgetragenen Überzügen aus nicht metallischen Werkstoffen</p>		
73 164	Umfang:	18 Seiten
<p><small>Vordruck-Leitverlag Berlin, Ag 900/70/DDR - (52) 7003</small></p>		

Figure 2: Example of an economic patent

3. Structure of a GDR patent

The structure of the patent specification in the GDR changed over the years. In earlier years the patent specifications (see Figures 1 and 2 in Chapter 2) did not entail identification numbers, so-called INID codes, which were later on placed in front of each piece of bibliographic data. Figures 3 and 4 below show examples of

patent specifications from the late 1970s and the 1980s that entail such an INID code. The uniform INID codes are applied by all patent offices according to WIPO standard ST. 9 and allow a consistent understanding of the essential items on the first page of a patent specification, notwithstanding the language of the patent specification. From the year 1977 or patent number DD123500 onward, the INID codes are included in the GDR patent specifications.

In the following, we explain the meaning of some INID codes that were most frequently used for GDR patents and describe the respective items.⁷ These codes encompass:

- (11) Patent or identification number
- (12) Kind of the document, i.e. type of patent
- (19) Country
- (21) Application number ("*Aktenzeichen*")
- (22) Date of filing the application
- (32) Date of filing priority application(s)
- (44) Publication date
- (51) IPC class
- (54) Title of the invention
- (55) Keywords
- (57) Abstract, i.e. description of the invention
- (71) Applicant
- (72) Inventor
- (73) Owner
- (74) Attorney or agent, i.e. representative

The patent or identification number (11) was assigned to each patent with consecutive numbering by the AfEP. The number ranges between 1 and 302,036. However, there are gaps between the numbers 160,000 and 200,000. Therefore,

⁷ For the full list of INID codes, see WIPO standard ST. 9 (<https://www.wipo.int/export/sites/www/standards/en/pdf/03-09-01.pdf>) and part 7.6 of the Handbook on Intellectual Property Information and Documentation entitled "Survey of bibliographic information contained in patent gazettes and in current indexes inserted in patent gazettes or published separately in association with patent gazettes" (<https://www.wipo.int/export/sites/www/standards/en/pdf/07-06-01.pdf>).

the total number of GDR patents is below the last granted integer 302,036 and amounts to 261,822.⁸

At the end of the identification number, there is usually a code indicating a specific kind of patent. In most cases, the AfEP used one of the following codes: A1, A2, A3, A4, A5, A6, A7, A8, B1, B3, C2, and C4.⁹ Each code stands for a respective legislation that was in force at the time of application or examination. For instance, A1 or A3 indicates an economic patent issued by the East German patent office, and distinguishes between the examination procedures of the protection requirements or the status of claims, whereas A2 means a supplement of the economic patent and A5 stands for an exclusive patent under the Patent Law of the GDR.¹⁰ The kind of the document (12) corresponds to the type of patent and, thus, concerns the economic or exclusive patent. "DD" designates the patent office of the country GDR and is introduced by code (19) uniformly in all GDR patent documents.

The dates have the following chronological order: (22) filing date before (44) publication date. In case of a foreign patent, which mostly corresponds to an exclusive patent, the date of filing the priority application (32) is also specified and it precedes (22) and (44) (see Figure 3 below).¹¹

The IPC class (51) contains only one main class and can include several secondary classes. It was introduced internationally only in 1968 and was ex-post assigned by the patent office to patents of earlier years. The IPC contains one of the capital letters A-H, which represent the following fields of technology, as well as various digits for the respective subclasses (DPMA, 2019a):

A Human necessities

B Performing operations; Transporting

⁸ While digitalizing the patents, 103 additional identification numbers were detected in the register for which respective patent documents did not exist. Therefore, the respective IDs can be regarded as erroneous data entries (see the full list in column 1 of Table A1 in the Appendix).

⁹ In very few cases also the following codes were used: A9, B2, B4, B5, C5, and T9 as well as just the letters A and B without an integer.

¹⁰ For a detailed overview see Part 7.3.2 of the WIPO Handbook on Intellectual Property Information and Documentation (2020) pp. 34-40: https://www.wipo.int/standards/en/part_07.html

¹¹ The order of dates was sometimes incorrect in the database and was manually corrected (see below).

C Chemistry; Metallurgy

D Textiles; Paper

E Fixed constructions

F Mechanical engineering; Lighting; Heating; Weapons; Blasting

G Physics

H Electricity

The applicant (71), inventor (72), owner (73), and legal representative (74) may be the same in some cases (e.g., in case of patent [DD0000124680B2](#), inventor and owner are the same person, whereas the applicant and the representative are the same organization). The institution for which the inventor worked is often mentioned as applicant or owner of a GDR patent. In addition to the surname, first name and, if applicable, the academic title of the inventor, the data for (71)-(74) also contain the geographical location of the applicant, inventor, and/or owner.¹² Several persons may be named. The geographic information may contain the street and house number, the city, the postcode, and the country. This data is presented in a full or abbreviated designation.

Changes in the structure of the patent specification over time led to challenges in the machine processing of the data by the DPMA, which in turn made some manual processing of the retrieved data necessary. The applied data processing is described in the following section.¹³

¹² It should be mentioned that the geographical location is often missing for physical persons, and in case of combines only the location of the headquarter is given. For patents generated within the Academy of Science mostly the patent office (*Patentbüro*) of the Academy in Berlin is named. Therefore, the location identification is in many cases problematic and can be mostly done for patents of the last two years of the GDR, i.e. 1989-90 (see Section 6 below).

¹³ In several cases, the ISSN is listed in the lower left margin, which was not transferred to the database. In the lower right margin of the patent, there is often an indication of the number of pages of the patent specification, which was also not transferred to the database.



PATENTSCHRIFT 127 756

Ausschließungspatent
Erteilt gemäß § 5 Absatz 1 des Änderungsgesetzes zum Patentgesetz
In der vom Anmelder eingereichten Fassung veröffentlicht

			Int. Cl. ²
(11)	127 756	(44)	12.10.77 2(51) A 61 M 11/00
(21)	AP A 61 m / 196 263	(22)	10.12.76
(31)	7514 067-3	(32)	12.12.75 (33) SW

(71) siehe (73)



(72) Wetterlin, Kjell I. L., Dr., SW

(73) Aktiebolaget Draco, Lund, SW

(74) Internationales Patentbüro Berlin, 102 Berlin, Wallstraße 23/24

(54) Aerosolinhalator

(57) Der Aerosolinhalator zum Inhalieren pharmakologisch aktiver Substanzen durch einen Inhalierauslaß besitzt eine austauschbare Einheitsdosierkapsel mit einer Membran, die perforierbar ist, wobei die Kapsel eine Einheitsdosis aktiver Substanz in Fließmittel- oder Pulverform und ein unter Druck stehendes Treibmittel enthält. Die Einheitsdosierkapsel ist zwischen zwei Bechern gehalten, wobei der eine Becher ein mittleres Loch aufweist, durch welches eine Perforiernadel hindurchbringbar ist, die ein Kapillarlängsrohr aufweist, welches ein Zuführrohr für eine Sprühdüse bildet, die auf der Perforiernadel angebracht ist. Die Sprühdüse ist innerhalb eines Inhalierauslasses, welcher in den Mund des Patienten eingebracht werden soll, zur Führung des abgegebenen Aerosols angebracht. Die Einheitsdosierkapsel und die Perforiernadel sind relativ zueinander derart verschiebbar, wobei die Perforiernadel zum Durchstechen der Einheitsdosierkapsel drückbar ist. Die Einheitsdosierkapsel, die Becher und die Perforiernadel sind innerhalb eines Gehäuses angeordnet an welchem der Inhalierauslaß befestigt ist.

(32) Ag 141 65 79 40 7762

14 Seiten
AIEP 2661

Figure 3: Example of a patent from the late 1970s

DEUTSCHE DEMOKRATISCHE REPUBLIK		PATENTSCHRIFT	
	(12) Wirtschaftspatent	(19) DD	(11) 263 536 A1
	Erteilt gemäß § 17 Absatz 1 Patentgesetz	4(51) C 11 D 7/06	
AMT FÜR ERFINDUNGS- UND PATENTWESEN		In der vom Anmelder eingereichten Fassung veröffentlicht	
(21)	WP C 11 D / 306 204 7	(22)	20.08.87
		(44)	04.01.89
(71)	VEB Chemiekombinat Bitterfeld, Bitterfeld, 4440, DD		
(72)	Hambrock, Dieter, Dipl.-Chem.; Baumgärtel, Rolf, Dipl.-Mineraloge; Heinrich, Klaus-Dieter, Dipl.-Chem.; Holtz, Helmar, Dipl.-Ing.; Meissner, Gerhard, Dipl.-Chem., DD		
(54)	Abflußreiniger mit tensidbildender Wirkung		
(55)	Abflußreiniger, tensidbildende Wirkung, Ätznatron, Aluminiumgrieß, agglomerierte Komponente, Natriumorthosilikat, Natriumtriphosphat, Carbonsäuren (C ₄ bis C ₂₃), organische Komplexbildner		
(57)	Die Erfindung beinhaltet einen Abflußreiniger mit tensidbildender Wirkung. Die Erfindung betrifft ein Mittel zur Reinigung von Abflüssen, Rohren, Syphons u. ä., das starke emulgierende, dispergierende und schmutztragende Wirkungen bei seiner Auflösung und Umsetzung im Wasser besitzt. Das Mittel besteht aus einem Gemisch von festen Ätznatron, Aluminium in Form von Pulver, Grieß, Granalien oder Spänen und einer agglomerierten Komponente in Kugelform von 0,3 bis 3 mm Durchmesser, die in Natriumorthosilikat eingebundenes, feinverteiltes Ätznatron, Carbonsäuren mit Kettenlängen im Bereich von C ₄ bis C ₂₃ sowie polymeren Phosphaten mit Anteilen an organischen Komplexbildnern und gegebenenfalls Riech- und Farbstoffen.		
ISSN 0433-6461		4 Seiten	

Figure 4: Example of a patent from the 1980s

4. Methods

4.1 Data source

With the unification of the two German states in 1990 and the Unification Treaty, the patent law of the FRG became effective in the territory of the former GDR. The patents of the AfEP were transferred to the DPMA and included in the German Patent Information System (DEPATIS) database (DPMA 2019b). For the compilation of the CPDB, we used the online version of the document archive *DEPATISnet*. DEPATIS contains data on granted patent applications of the GDR for the period from 1949 to 1990, including both economic and exclusive patents (DPMA, 2021b). The *DPMAregister* platform, which is the official register for all patent applications, also provides an electronic data set with current legal and procedural status information from 1981 onwards (DPMA, 2019c). However, considering the information available, this data set is incomplete, as not all data

from the GDR patent specifications were correctly transferred to DEPATIS. Figure 5 shows an example of the information from a patent specification. The contents of the text correspond to the information in the patent document, but it is in a machine-readable format, illustrating the information that can be retrieved from DEPATIS.

Dieser Text wurde mittels automatischer OCR-Wandlung aus dem Originaldokument erzeugt und kann daher fehler- und/oder lückenhaft sein. Er enthält keine Zeichnungen. Tabellen und Formeln können eine schlechte Darstellungsqualität haben oder ganz fehlen.

DD 00000258791 A1

Anmeldeland: DD
Anmeldenummer: 29388688
Anmeldedatum: 27.08.1986
Veröffentlichungsdatum: 03.08.1988
Hauptklasse: B65H 29/24
MCD-Hauptklasse: B65H 29/24(2006.01.A)
MCD-Nebenkategorie: B65H 29/68(2006.01.A)
CPC: B65H 29/688
CPC: B65H 2801/21
ECLA: B65H 29/68 B
Erfinder: WIERTH GERD, DD
Erfinder: ZIMMERMANN HANS, DD
Anmelder: POLYGRAPH LEIPZIG, DD

[DE]ANORDNUNG VON SAUGRINGEN IN BOGENBREMSEN VON BOGENAUSLEGERN

[DE]Die Erfindung betrifft eine Anordnung von Saugringen in Bogenbremsen von Bogenauslegern in Druckmaschinen. Die Bogenbremsen sind vor dem Auslegerstapel angeordnet und bestehen aus einer Saugringtraverse, einer Vierkantwelle als Antrieb, darauf axial verschiebbare voneinander beabstandete Saugringe sowie einer Saugluftzuführung. Aufgabe der Erfindung ist es, eine Anordnung von Saugringen in Bogenbremsen zu schaffen, die eine axiale Verstellung der Saugringe gestattet und in jeder Einstellung gewährleistet, dass der Saugring mit einer definierten Kraft am Saugringlager anliegt. Erfindungsgemäss wird das dadurch erreicht, dass auf der Antriebswelle drehfest ein in den Saugring eingreifendes Drehübertragungselement vorgesehen ist. Das Drehübertragungselement ist federbelastet einer starr mit dem Saugringlager verbundenen Kugellaufbahn und der Saugring federbelastet einem starr mit dem Saugringlager verbundenen Anlauftring zugeordnet. Das Drehübertragungselement ist verschiebbar auf der Antriebswelle angeordnet.

Seite 1 --- (BI, AB)

Seite 2 --- (CL, DE)

1. Anordnung von Saugringen in Bogenbremsen von Bogenauslegern, wobei eine Antriebswelle und Saugringe vorgesehen sind, jeder Saugring einem Saugringlager zugeordnet ist und die Beaufschlagung des Saugringes über das Saugringlager erfolgt, dadurch gekennzeichnet, daß auf der Antriebswelle (7) drehfest ein in den Saugring (1) eingreifendes Drehübertragungselement (2) vorgesehen, das Drehübertragungselement (2) federbelastet einer starr mit dem Saugringlager (3) verbundenen Kugellaufbahn (4) und der Saugring (1) federbelastet einem starr mit dem Saugringlager (3) verbundenen Anlauftring (6) zugeordnet ist.

2. Anordnung nach Anspruch 1, dadurch gekennzeichnet, daß das Drehübertragungselement (2) verschiebbar auf der Antriebswelle (7) angeordnet ist.

Hierzu 1 Seite Zeichnungen

Anwendungsgebiet der Erfindung

Die Erfindung betrifft eine Anordnung von Saugringen in Bogenbremsen von Bogenauslegern in Druckmaschinen.

Die Bogenbremsen sind vor dem Auslegerstapel angeordnet und bestehen aus einer Saugringtraverse, einer Vierkantwelle als Antrieb, darauf axial verschiebbare voneinander beabstandete Saugringe sowie einer Saugluftzuführung.

Charakteristik des bekannten Standes der Technik

Aus der DD 215060 ist eine Anordnung von Saugringen in Bogenbremsen von Bogenauslegern in Druckmaschinen bekannt, wobei die Saugringe mit dem Saugringlager fest einer relativ bewegten Welle und einem feststehenden Saugringlager zugeordnet sind. Die Saugringe werden über das Saugringlager pneumatisch beaufschlagt und mittels eines fest am Saugringlager angeordneten Andruckringes und Druckfedern gegen das Saugringlager gedrückt.

Nachteilig an dieser Bogenbremse ist, daß sich bei axialer Verstellung der Saugringe zwischen den Stimmflächen der Laufpaarung Saugring/Saugringlager ein Luftspalt bilden kann, insbesondere dann, wenn die Klemmkraft zwischen der Antriebswelle und dem Saugring größer ist als die Andruckkraft der Federn. Das führt dazu, daß Falschluf gezogen und damit der Unterdruck reduziert wird, was bis zur völligen Wirkungslosigkeit der Bogenbremse führen kann.

Dieser Sachverhalt kann auch, bedingt durch Fertigungsungenauigkeiten oder infolge der Durchbiegung der Antriebswelle, während des Fortdruckes auftreten.

Der Nachteil bedingt zusätzliche Stellhandlungen bzw. führt zu Störungen im Produktionsablauf.

Ziel der Erfindung " #-:#

Es ist Ziel der Erfindung, eine funktionssichere Bogenbremse in Bogenauslegern von Druckmaschinen zu schaffen, bei der eine axiale Verstellung ohne zusätzliche Bedienhandlungen möglich ist.

Darlegung des Wesens der Erfindung

Aufgabe der Erfindung ist es, eine Anordnung von Saugringen in Bogenbremsen zu schaffen, die eine axiale Verstellung der Saugringe gestattet und in jeder Einstellung gewährleistet, daß der Saugring mit einer definierten Kraft am Saugringlager anliegt. .

Erfindungsgemäss wird das dadurch erreicht, daß auf der Antriebswelle drehfest ein in den Saugring eingreifendes Drehübertragungselement vorgesehen ist. Das Drehübertragungselement ist federbelastet einer starr mit dem Saugringlager verbundenen Kugellaufbahn und der Saugring federbelastet einem starr mit dem Saugringlager verbundenen Anlauftring zugeordnet. Das Drehübertragungselement ist verschiebbar auf der Antriebswelle angeordnet.

Ausführungsbeispiel

An einem Ausführungsbeispiel soll nachfolgend die Erfindung näher erläutert werden. In den Zeichnungen zeigt

Fig. 1: die Draufsicht auf eine Saugringanordnung
Fig. 2: die Seitenansicht längs der Linie A-A gem. Fig. 1

Figure 5: Example of a patent specification in text format

4.2 Data preparation

All corrections and extensions performed for the published CPDB concern the inventor and applicant data as well as the application and publication dates. In case the data extraction performed by the DPMA in the process of patent digitalization resulted in incorrect data, we sought to correct all detected errors manually.

The following data preparation steps were performed:

Step 1: The raw data was extracted from the *DEPATISnet* database by the Patent Information Centre of the Friedrich Schiller University Jena in the year 2019 based on a search query. Data access was limited to a maximum of 1,000 patents per query. The project team at the Friedrich Schiller University Jena processed the raw data and created the database.

Step 2: The team at the University of Bremen was responsible for further processing of these data. This particularly included manual data cleaning as well as subsequent creation, preparation, and archiving of the database.

Step 3: The team at the Friedrich Schiller University Jena created an additional module with regional information for the patents of the years 1989 and 1990 (see Section 6).

Each summary table downloaded in step 1 contained the following information listed in columns: 1) serial number, 2) publication number, 3) filing date, 4) publication date, 5) IPC main class, 6) IPC minor/index classes, 7) reclassified IPC, 8) DEKLA IPC, 9) inventor, 10) applicant/owner, 11) title, 12) abstract, 13) PDF URL, and 14) searchable text URL. This resulted in a total of approximately 300 Excel tables, which were transferred to a database. In addition to the overview tables in Excel format, all related patent specifications were downloaded in PDF format.

The content of columns 1)-6) as well as 9)-12) is automatically retrieved from the patent specification of the DPMA and corresponds to the INID codes of the same names (see Chapter 3). Columns 7)-8) and 13)-14) reflect information that is not directly contained in the patent specification. Column 7) stands for the state-of-the-art adapted and reclassified IPC classes. Since the technical

definitions may change with each IPC revision, individual documents are reclassified using WIPO's Master Classification Database (MCD). The reclassification is not done in the patent document but in the database (DPMA 2020). Column 8) entails an adjusted technological classification. This adjustment is made by the experts of the DPMA, who believe that in certain cases the technological area specified in the patent document is not accurately and/or solely reflected in the given IPC code(s). This column may contain not only internationally listed IPC codes, but also codes from a more refined German patent classification ("*Deutsche Patent-Feinklassifikation*", DEKLA). These so-called Prüfstoff IPC and reclassified IPC are not assigned in all cases by the DPMA examining staff, and therefore, columns 8) and 9) have many missing values that cannot be filled out manually. Columns 13) and 14) represent hyperlinks that contain the copy of the original patent specification and the patent text that has been generated from the original document by using automatic Optical Character Recognition (OCR) conversion, respectively. The latter document is deprived of any drawings and allows a quick information search within the patent document.

In step 2, the details of the applicants and inventors in all empty fields were manually compared with the data in the respective patent specifications, digitized, and supplemented. For the applicant/owner, all persons indicated under INID codes (71) and (73) were added from the patent specification. In some cases, the information on the representative (74) was added.

In some cases, the machine reading of the application and publication data by the DPMA led to inadequate recording of the dates. For example, there was an indication that a patent was published in 1968 but not filed until 1988. In such cases, the year of filing and the year of publication were manually checked and corrected. In addition, patents for which the publication date corresponds to the application date were manually checked and the information was corrected.

The date format was adjusted to the standard DD.MM.YYYY for all patents.

The placeholders in the title and abstract were removed and the language information from the text (DE or EN) was transferred to a new column

(sprachetitel and spracheabstract). Obvious transfer errors that led to incorrect information in the title were corrected manually. The CPDB was prepared according to the formal requirements of the Leibniz Institute for the Social Sciences (GESIS) and the necessary information was added.

There were several erroneous entries in the database. The respective patent numbers are summarized in Table A1 in the Appendix. For instance, the digitized but non-existing 103 patents data mentioned in Footnote 2, were manually removed from the database, as they do not represent patents. They are listed in Table A1, column 1.

In addition, the downloaded DPMA database contains 49 patent entries for which an IPC class was automatically generated but no patent specification exists. Such patent entries were removed from the GDR patent database. The corresponding publication numbers are documented in the Appendix in Table A1, column 2.

Furthermore, there were obvious date errors for 47 patents. In these cases, the documents contain handwritten or difficult-to-read information for which the text recognition automatically assigned the date 31.12.9999. Patents with this date are listed in Table A1, column 3. They were manually checked and corrected for the GDR patent database. If publication data was non-existent or difficult to read, which was the case in 19 patent documents, the date information could not be corrected and a "NULL" was assigned. Any other filing and publication dates with missing values could be corrected. Figure 6 shows an excerpt from the final GDR patent database.

veroeffen	anmelded	veroeffen	ipchauptk	ipcnebeni	reklassifiz	pruefstoff	erfinder	anmelder	titel	sprachetit	abstract	spracheat	pdfurl	recherchi	nameappl	type	gemeinde
DD000000	09.04.1990	05.09.1991	B41J 2/45		B41J 2/45	B41J 2/45	GUHR HOL	ROBOTRO	VERFAHR	DE	Die Erfinc	DE	https://de	https://de	VEB Robo	3	16068051
DD000000	09.04.1990	05.09.1991	B41J 3/21	B41J 2/43	G11B 7/00	B41J 2/45	GUHR HOL	ROBOTRO	SCHALTUI	DE	Die Erfinc	DE	https://de	https://de	VEB Robo	3	16068051
DD000000	12.04.1990	05.09.1991	B41J 29/2	B41J 33/5	B41J 29/2	B41J 29/2	GRAICHEN	ROBOTRO	VERFAHR	DE	Die Erfinc	DE	https://de	https://de	VEB Robo	3	14511000
DD000000	11.04.1990	05.09.1991	B42F 7/12		B42F 7/12	B42F 7/12	SIMON BE	SCHWERIM	ABLAGES	DE	Die Erfinc	DE	https://de	https://de	VEB Plastv	3	13004000
DD000000	10.04.1990	05.09.1991	B60K 41/0		B60K 28/1	B60K 28/1	BATISTIC I	TEVES GM	SCHALTUI	DE	Die Erfinc	DE	https://de	https://de	Ausland	1	
DD000000	09.04.1990	05.09.1991	B61D 17/0		B61D 17/0	B61D 17/0	ALBRECHT	AMMENDI	VERFAHR	DE	Die Erfinc	DE	https://de	https://de	Waggonb	3	15002000
DD000000	23.03.1990	05.09.1991	B61F 1/14	B61F 1/00	B61D 5/06	B61F 1/14	BEIER GUE	LINKE HOF	UNTERGE	DE	Um bei ei	DE	https://de	https://de	Ausland	1	
DD000000	23.03.1990	05.09.1991	B61F 1/14	B61D 5/06	B61D 5/06	B61F 1/14	GEISE KLA	LINKE HOF	ABSTUETZ	DE	Um bei ei	DE	https://de	https://de	Ausland	1	
DD000000	09.04.1990	05.09.1991	B63B 23/3		B63B 23/3	B63B 23/3	ENDE RUD	VOLKSWE	AUSSETZ	DE	Die Erfinc	DE	https://de	https://de	VEB Volks	3	13073088
DD000000	09.04.1990	05.09.1991	B65B 13/0	B65B 13/1	B65B 13/3	B65B 13/1	LAASS GEF	THAELMA	VORRICH	DE	Die Erfinc	DE	https://de	https://de	VEB Schw	3	15003000
DD000000	09.04.1990	22.07.1990	B65B 13/0	B65B 13/1	B65B 13/3	B65B 13/1	LAASS GEF	THAELMA	VORRICH	DE			https://de	https://de	SKET Schw	3	15003000
DD000000	17.07.1980	05.09.1991	B65G 47/1		B65G 47/1	B65G 47/2	HARBAUEI	INST GETR	EINRICHT	DE	Die Erfinc	DE	https://de	https://de	VEB Instit	3	12069454
DD000000	09.04.1990	05.09.1991	B65G 65/3		B65G 65/3	B65G 65/4	NELLEN H	AGROANL	VERFAHR	DE	Die Erfinc	DE	https://de	https://de	VEB Agroa	3	14625020
DD000000	12.04.1990	05.09.1991	B65H 3/08	B21D 43/2	B65H 3/08	B65H 3/08	LIEPERT R	SPIESS GM	ANLEGEV	DE	Bei einer	DE	https://de	https://de	Ausland	1	
DD000000	30.03.1990	05.09.1991	B65H 5/10		B41F 21/0	B41F 21/0	HEFFTLER	PLANETA	EINRICHT	DE	Die Erfinc	DE	https://de	https://de	Planeta, t	3	14627210
DD000000	09.04.1990	05.09.1991	B65H 75/0		B65H 75/0	B65H 16/0	JOCKISCH	NEPTUN S	KABELLA	DE	Die Erfinc	DE	https://de	https://de	VEB Schiff	3	13003000
DD000000	12.04.1990	05.09.1991	B66C 7/08		B66C 7/08	B66C 7/08	ANGRIK J	VERLADE	BEFESTIG	DE	Die Erfinc	DE	https://de	https://de	VEB Verla	3	14713000
DD000000	12.04.1990	05.09.1991	C01B 15/0		C01B 15/0	C01B 15/0	FAESEY N	INTEROX	VERFAHR	DE	Die Erfinc	DE	https://de	https://de	Ausland	1	
DD000000	10.04.1990	05.09.1991	C01B 17/6		C01B 17/6	C01B 17/6	FUERTIG	H UNIV BER	VERFAHR	DE	Die Erfinc	DE	https://de	https://de	Humboldt	3	11000000
DD000000	30.10.1980	05.09.1991	C01G 51/0		C01G 51/0	C01G 51/0	REETZ TE	AKAD WIS	VERFAHR	DE	Kobaltalu	DE	https://de	https://de			
DD000000	12.04.1990	05.09.1991	C02F 1/74		C02F 1/58	C02F 1/50	COOPER K	ALBRIGHT	VERFAHR	DE	Die Erfinc	DE	https://de	https://de	Ausland	1	
DD000000	30.03.1990	05.09.1991	C02F 3/12	C12Q 1/12	C02F 3/12	C02F 3/12	GOLDBER	WASSERV	EINRICHT	DE	Die Erfinc	DE	https://de	https://de	Wasserve	3	11000000

Figure 6: Excerpt from the CPDB

5. Comprehensive Patent Database (CPDB)

The final database contains all granted patents of the GDR published by AfEP (later DPMA) in the period between January 1, 1939 (application before but granted in the GDR) and June 29, 2006 (application in but granted after the GDR). The core database covers the years 1950 to 1990 and contains 24 variables with manually cleaned and processed information on a total of 286,478 patent entries, which correspond to 261,822 unique GDR patents. This difference can be explained by the fact that for around 24,500 patents (around 9% of all entries), several (up to 3) documents of the patent family are included in the database. The CPDB of the GDR is freely available in Excel format (.xlsx) as well as delimited text file (.csv) at the Leibniz Institute for the Social Sciences (GESIS); <https://doi.org/10.7802/2423>. Figure A1 in the Appendix shows a yearly amount of granted patents in the GDR according to the publication date. Most patents were published in the late 1980s with the year 1985 being a forerunner, when 14,744 patents were published.

Information is missing in the database if it is not included in the patent specifications. In several cases, this concerns the IPC secondary classes and the abstract. For the years before 1975, only a few abstracts are available. In total, abstracts are missing for 165,740 patents.

Despite its availability in the patent documents, data may be missing in the database in case of more than one applicant or inventor, because the focus in preparing the data was on completing the empty lines. In addition, it is often not possible to distinguish between applicant and owner if, for example, only headquarters or the patent attorney are named. The patent attorney is included in the variable *anmelderinhaber*, although he or she is not the inventor or applicant. Rarely, there is no information on the inventor in the patent specifications (coded as "is not named") because he or she did not want to be mentioned as an inventor. For the supplementary module with the regional data for 1989/90, the inventor names are considered sensitive data and are anonymized by the designation "inventor".

In a few cases, there are transcription errors, with the correct data being contained in the patent specifications but not in the database. This is particularly the case for handwritten annotations or special fonts that could not be processed without error by the text-recognition system. The correct information could then be found in the PDF files of the patent specification. In some cases, no PDF URL to the patent specifications could be retrieved; in this case, the searchable text had to be used. Table 1 provides an overview of the variables, their description, and further notes.

Table 1: Variable description

<i>Variable</i>	<i>Description</i>	<i>Document/Notes</i>
veroeffentlichungsnummer	Publication number of the granted patent application assigned by the German Patent and Trademark Office (DPMA)	DPMA INID-Code* 11 Note: Corresponds to the columns publ_auth, publ_nr, and publ_kind from the PATSTAT table tls211_pat_publn
anmeldedatum	Patent application date	DPMA INID-Code 22 (DPMA, 2014)
veroeffentlichungsdatum	Date of publication of the patent	DPMA INID-Code 44 or 45 (DPMA, 2014)
ipchauptklasse	Main class or technical focus of the patent	DPMA INID-Code 51 (marked bold) Note: PATSTAT does not distinguish between the 1st and other IPC classes
ipcnebenindexklassen	Further technical fields (IPC secondary classes) to which the patent can be assigned	DPMA INID-Code 51 Note: PATSTAT does not distinguish between the 1st and other IPC classes (DPMA, 2020)
reklassifizierteipcmcd	State-of-the-art adapted and reclassified IPC classes	Since the technical definitions may change with each IPC revision, individual documents are reclassified using WIPO's Master Classification Database (MCD). The reclassification is not done in the patent document but in the database (DPMA, 2020).
pruefstoffipc	More refined German patent classification ("Deutsche Patent-Feinklassifikation", DEKLA)	Classification by experts of the DPMA after allocation of the bibliographic IPC (DPMA, 2020)
Erfinder	Inventor of the patent	DPMA INID-Code 72 (DPMA, 2014)
anmelderinhaber	Patent applicant OR/AND patent owner OR/AND representative (usually the patent attorney)	DPMA INID code 71 OR/AND 73 AND/OR 74 (DPMA, 2014)
Titel	Patent title	INID-Code 54
sprachetitel	Language of the title of the patent	
Abstract	Description of the patent	INID-Code 57
spracheabstract	Language of the abstract of the patent	
Pdfurl	Link to the patent specification in the DPMA database	
recherchierbarertexturl	Machine-readable document generated by the DPMA by means of OCR without graphics	May be incorrect because automatically generated
nameapplicantcleaned	Detailed recording of the name of the patent holder	Only available for the years 1989 and 1990 (see chapter "Regional information"). The inventors' names are anonymized.
type	Type of patent holder (1: foreign country; 2: GDR company; 3: GDR inventor; 4: foreign country with participation of GDR inventors)	Only available for the years 1989 and 1990 (see chapter "Regional information")
gemeinde_**	Municipality number (as of 2021) where the seat of the patent holder was located	Only available for the years 1989 and 1990 (see chapter "Regional information")

* INID codes are numbers for identifying bibliographic data according to WIPO standard ST. 9 and are used by all patent offices. From 1977 or DD123500, the INID codes are noted on the GDR patents.

** Numbers 1 to 7.

6. Regional information

For a total of 17,772 patents from 1989 and 1990, the CPDB contains additional information that could be usefully recorded because of a change in the database. In the course of a reform of the GDR patent law in June 1990, the documentation of applicants and inventor information was also improved. Whereas previously only the combine or the parent company was mentioned as the applicant, from summer of 1990 onwards, the actual applicant establishment of the combine was also named in the entries. Furthermore, some of the address data of the inventor(s) was entered. In practice, this change means that GDR patent applications of the years 1989 and 1990, which were granted from summer 1990 onwards, either before or after German reunification, open up the possibility to assign a patent to a certain location, thereby identifying the regional structure of innovation activities in the GDR (see exemplary patent from 1990 in Figure 7). For patent applications prior to 1989, we know only the headquarter of the respective combine (*Kombinatszentrale*) that is indicated as applicant in the patent specification. Since the establishment of the combine that generated the invention was often located in considerable distance to the headquarter, there was no way to link a patent to a certain region. Moreover, for the indicated period it is also possible to distinguish the exact location of the research institute.¹⁴

Against this background, we additionally extracted information from the original PDFs of the patent specifications for the GDR patents of the years 1989 and 1990 in order to identify the location of the patent applicants/owners in more detail than in the DPMA database. After cleaning the applicant and owner data, we assigned a municipality (*Gemeinde*) number (as of 2021) to each applicant. For patents with several applicants in different municipalities, several municipality numbers (up to 7 municipalities) were assigned to the patent. If the patent applicants are also the inventors, they are assigned a municipality number

¹⁴ While in the earlier years, the location is mostly allocated to the Academy of Science in Berlin, the regional module allows to identify the precise location. It turns out that among all patents registered by the Academy of Science, roughly half of them stem from Berlin, while the others were scattered around the GDR. Overall, less than 10% of all patents in 1989 and 1990 were applied for by the Academy of Science.

based on the inventors' place of residence. Patents of foreign applicants are marked separately.

(19) BUNDESREPUBLIK DEUTSCHLAND

PATENTSCHRIFT

(11) **DD 292 077 A5**

(12) Ausschließungspatent

Erteilt gemäß § 17 Absatz 1
Patentgesetz der DDR
vom 27. 10. 1983
in Übereinstimmung mit den entsprechenden
Festlegungen im Einigungsvertrag

5(51) G 01 D 5/12
G 01 D 5/02

DEUTSCHES PATENTAMT In der vom Anmelder eingereichten Fassung veröffentlicht

(21)	DD G 01 D / 337 779 6	(22)	12.02.90	(44)	18.07.91
------	-----------------------	------	----------	------	----------

(71) VEB IFA-Motorenwerke Nordhausen, Freiherr-vom-Stein-Straße 30 c, O - 5500 Nordhausen, DE
 (72) Artymiak, Dieter, Dr.-Ing.; Bause, Hans-Jürgen, Dipl.-Ing.; Droste, Peter, Dipl.-Ing., DE
 (73) VEB IFA-Motorenwerke Nordhausen, O - 5500 Nordhausen; VEB Kombinat Landtechnik Erfurt, Ingenieurbüro für Rationalisierung Nordhausen, O - 5500 Nordhausen; VEB Anwendung Mikroelektronik Erfurt, O - 5020 Erfurt, DE

(54) **Einrichtung zur berührungslosen Messung frei einstellbarer Positionen translatorisch bewegter Teile**

(55) Messung; Position, translatorisch; Magnetkreis, geschlossen; Rahmenstruktur, rechteckig; Schichten; Bleche, L-förmig; Spulen;
 Magnetkreisbeeinflussungselement, berührungslos
 (57) Die Erfindung hat eine Einrichtung zur berührungslosen Messung frei einstellbarer Positionen translatorisch bewegter Teile zum Gegenstand und eignet sich für in Grenzen zueinander, insbesondere rhythmisch bzw. stochastisch bewegte Teile. Die Einrichtung besteht aus einem geschlossenen Magnetkreis (2) mit rechteckiger Rahmenstruktur und mehreren Schichten, wobei jede Schicht aus zwei L-förmigen Blechen (11) derart gebildet wird, daß das stirnseitige Ende des langen Schenkels (9) des einen L-förmigen Bleches an der Innenkante des kurzen Schenkels (10) des anderen L-förmigen Bleches anliegt. Die auf einer Seite des geschlossenen Magnetkreises (2) befindlichen langen Schenkel (9) werden von zwei mehrlagigen Spulen (3) umgeben, die mit ihrer äußeren Stirnseite an den benachbarten kurzen Schenkeln (10) anliegen, also maximal voneinander entfernt sind. Die nicht von den Spulen (3) umschlossenen langen Schenkel (9) sind von einem elektrisch leitenden, verwindungssteifen Magnetkreisbeeinflussungselement (4) berührungsfrei umgeben, das mit dem translatorisch bewegten Teil verbunden ist. Fig. 1

Fig. 1

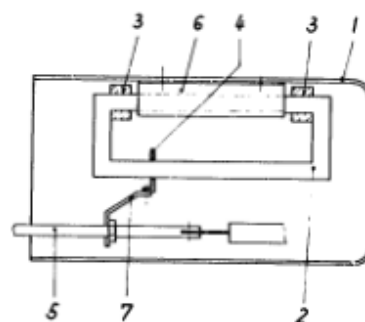

Figure 7: Exemplary patent from the year 1990

Note: Patents published after reunification and filed before 3rd October 1990 were published as exclusive patents.

References

- Acs, Z.J., Anselin, L., Varga, A., 2002. Patents and innovation counts as measures of regional production of new knowledge. *Research Policy* 31, 1069–1085. [https://doi.org/10.1016/S0048-7333\(01\)00184-6](https://doi.org/10.1016/S0048-7333(01)00184-6)
- Baar, L., Petzina, D., 1999. *Deutsch-deutsche Wirtschaft 1945 bis 1990: Strukturveränderungen, Innovationen und regionaler Wandel. Ein Vergleich*. St. Katharinen: Scripta Mercaturae.
- Bähr, J., Petzina, D. (eds.), 1996. *Innovationsverhalten und Entscheidungsstrukturen*. Berlin: Duncker & Humblot.
- Bergeaud, A., Verluise, C., 2022. *A new Dataset to Study a Century of Innovation in Europe and in the US*. Centre for Economic Performance. London School of Economics and Political Science. Discussion Paper no. 1850.
- DPMA, 2021a. 30 Jahre Deutsche Einheit - zwei deutsche Patentämter wurden eins. https://www.dpma.de/dpma/wir_ueber_uns/geschichte/30jahre_einheit/index.html
- DPMA, 2021b. Datenbestand. Munich: Deutsches Patent- und Markenamt. <https://depatisnet.dpma.de/DepatisNet/depatisnet?window=1&space=menu&content=index&action=datenbestand>
- DPMA, 2020. DPMAinformativ. Patentrecherche mit Klassifikationssymbolen. Munich: Deutsches Patent- und Markenamt.
- DPMA, 2019a. Die internationale Patentklassifikation IPC [WWW Document]. Munich: Deutsches Patent- und Markenamt. <https://www.dpma.de/recherche/klassifikationen/patenteundgebrauchsmuster/internationalepatentklassifikation/index.html>
- DPMA, 2019b. 1986 to 2000: The German Patent Office until the turn of the millennium. Munich: Deutsches Patent- und Markenamt.
- DPMA, 2019c. DPMA Register. Dateninhalt. Munich: Deutsches Patent- und Markenamt.
- DPMA, 2014. DPMAinformativ. Normierung von Patentliteratur. Munich: Deutsches Patent- und Markenamt.
- DPMA, 2012. DPMAinformativ. Aktenzeichenformate der verschiedenen Schutzrechtsarten im Deutschen Patent- und Markenamt seit 1877 bis heute. Munich: Deutsches Patent- und Markenamt.
- Fritsch, M., Greve, M., Wyrwich, M., 2022. Shades of a Socialist Legacy? Innovation Activity in East and West Germany 1925-2014. *Jena Economic Research Papers* (forthcoming)
- Glitz, A., Meyersson, E., 2020. Industrial Espionage and Productivity. *American Economic Review* 110, 1055–1103. <https://doi.org/10.1257/aer.20171732>
- Grupp, H., I. Dominguez-Lacasa and M. Friedrich-Nishio (2002): *Das deutsche Innovationssystem seit der Reichsgründung*. Physica-Springer, Heidelberg
- Grupp, H., Dominguez Lacasa, I., Friedrich-Nishio, M., Jungmittag, A., 2005. Innovation and growth in Germany over the past 150 years, in: Cantner,

U., Dinopoulos, E., Lanzillotti, R.F. (Eds.), *Entrepreneurships, the New Economy and Public Policy*. Berlin/Heidelberg: Springer, pp. 267–287.
https://doi.org/10.1007/3-540-26994-0_15

Günther, J., Hipp, A., Ludwig, U., 2020. Universalien der Innovation - Erfindertum und technischer Fortschritt in der DDR und dessen Rolle nach 1990. University of Bremen: Institute for Economic Research and Policy.
<https://doi.org/10.26092/ELIB/332>

Hemmerling, J., 1986. G.D.R. patent information system promotes the creation of modern high technologies as well as of complex innovation processes. *World Patent Information* 8, 206–209. [https://doi.org/10.1016/0172-2190\(86\)90028-1](https://doi.org/10.1016/0172-2190(86)90028-1)

Kogut, B., Zander, U., 2000. Did Socialism Fail to Innovate? A Natural Experiment of the Two Zeiss Companies. *American Sociological Review* 65, 169–190. <https://doi.org/10.2307/2657436>

Patentinformationsstelle der Friedrich-Schiller-Universität Jena, 2019. DDR Patentdaten. https://www.sft.uni-jena.de/Kontakt/Patent_+und+Schutzrechtsservice.html

Wiessner, M., 2015. Das Patentrecht der DDR, in: Otto, M. (ed.), *Geschichte des deutschen Patentrechts, Geistiges Eigentum und Wettbewerbsrecht*. Tübingen: Mohr-Siebeck, pp. 239–288.

WIPO, 1970. Paris Convention for the Protection of Industrial Property. Paris Notification No. 16. Entry into force of Articles 1 to 12 of the Stockholm Act.

Publications based on the data

Fritsch, M., Greve, M., Wyrwich, M., 2022. Shades of a Socialist Legacy? Innovation Activity in East and West Germany 1925-2014. Friedrich Schiller University Jena: Jena Economic Research Papers (forthcoming)

Hipp, A., Ludwig, U., Günther, J., 2022. Und sie wirkten doch: Patente und Produktivität in der DDR, in: Flade, F.; Steinkamp, A.; Walerski, K. (Eds): *Transformation in Polen und Ostdeutschland: Neue Einblicke in die Debatte über eine gespaltene Wirtschaft*. Harrassowitz Verlag, Wiesbaden, forthcoming.

Hipp, A., Ludwig, U., Günther, J., 2021. Unable to innovate or just bad circumstances? Comparing a state-led and market-based innovation system in Germany. University of Bremen: Papers on Economics & Innovation #2111. <https://doi.org/10.26092/elib/1330>

Günther, J., Hipp, A., Ludwig, U., 2020. Universalien der Innovation - Erfindertum und technischer Fortschritt in der DDR und dessen Rolle nach 1990. University of Bremen: Institute for Economic Research and Policy.
<https://doi.org/10.26092/ELIB/332>

Appendix

Table A1: Removed or adjusted data

No.	Column 1	Column 2	Column 3
	Non-existing patents	Non-existing patents with an automatically generated IPC class	Patents with text recognition errors
1.	DD000000175507B	DD000000020828A	DD000000002366A1
2.	DD000000045239A1	DD000000020831A	DD000000007596A1 (No date)
3.	DD000000086677A1	DD000000020862A	DD000000002970A5
4.	DD000000161313B1	DD000000033578A7	DD000000000161A1
5.	DD000000161572A	DD000000034403A	DD000000005933A1
6.	DD000000163525A	DD000000034464A	DD000000006810A1
7.	DD000000164201B	DD000000034473A	DD000000000486A1
8.	DD000000164412A	DD000000034485B	DD000000003082A1
9.	DD000000165747A	DD000000034486A	DD000000005165A1 (No date)
10.	DD000000168142A	DD000000034496A	DD000000003592A1 (No date)
11.	DD000000169016B	DD000000034497A	DD000000003874A5 (No date)
12.	DD000000172283B	DD000000034519A	DD000000007374A1 (No date)
13.	DD000000172877A	DD000000034589A	DD000000008019A5 (No date)
14.	DD000000173362B	DD000000034616A	DD000000007264A1 (No date)
15.	DD000000173380A	DD000000034634A	DD000000008035A1 (No date)
16.	DD000000173990A	DD000000034710A	DD000000007343A1 (Not granted)
17.	DD000000177196A	DD000000034717A	DD0000000293665B4
18.	DD000000177464B	DD000000034745A	DD000000007445A1 (No date)
19.	DD000000177560B	DD000000034749A	DD000000007154A1 (No date)
20.	DD000000177667A	DD000000034750A	DD000000007610A1
21.	DD000000177751B	DD000000034763A	DD000000008018A1 (No date)
22.	DD000000177753A	DD000000034788A	DD000000031816A1 (No year)
23.	DD000000177899A	DD000000035486A	DD000000054565A2 (No year)
24.	DD000000181545B	DD000000035492A	DD000000070909A1 (No date)
25.	DD000000181802B	DD000000035495A	DD000000075499A1
26.	DD000000181841B	DD000000035496A	DD000000076423B1
27.	DD000000182274A	DD000000035497A	DD000000079613B1 (No month and no year)
28.	DD000000183339B	DD000000035499A	DD000000120721B1
29.	DD000000183500B	DD000000035500A	DD000000084335A5
30.	DD000000184294A	DD000000035501A	DD000000108451B1
31.	DD000000185162A5	DD000000035503A	DD000000113506B1

32.	DD000000185369B	DD000000035506A	DD000000117313B1
33.	DD000000185649B	DD000000035507A	DD000000260261B5
34.	DD000000185943A	DD000000035508A	DD000000001856B1
35.	DD000000186024B	DD000000035512A	DD000000012337A5 (No date)
36.	DD000000187291A	DD000000035517A	DD000000050802A1 (No date)
37.	DD000000187987B	DD000000035581A	DD000000058053A1 (No day)
38.	DD000000188466A	DD000000035585A	DD000000116327B1
39.	DD000000189256B	DD000000035587A	DD000000004663B1
40.	DD000000189262A	DD000000084291C2	DD000000028286A1
41.	DD000000189311A	DD000000172970A	DD000000030198A1
42.	DD000000189314B	DD000000174750B	DD000000044923A5
43.	DD000000189399A	DD000000176479A	DD000000045739A1
44.	DD000000189778A	DD000000195481A	DD000000064160B1
45.	DD000000190063B	DD000000198487A	DD000000116625B1
46.	DD000000190603B	DD000000198804A	DD000000207849B1
47.	DD000000190973B	DD000000199130A	DD000000063147A5 (No day)
48.	DD000000191067B	DD000000199722A	
49.	DD000000191340B	DD000000291454A5	
50.	DD000000191759A		
51.	DD000000192553A		
52.	DD000000192969A		
53.	DD000000193093A1		
54.	DD000000193386B		
55.	DD000000193465A		
56.	DD000000193468B		
57.	DD000000194411B		
58.	DD000000194631B		
59.	DD000000194776B		
60.	DD000000195426A		
61.	DD000000195506B		
62.	DD000000195850A		
63.	DD000000195922B		
64.	DD000000195948B		
65.	DD000000196198B		
66.	DD000000196289A		
67.	DD000000196474A		
68.	DD000000196698A		
69.	DD000000196733B		

70.	DD000000196780A		
71.	DD000000196781A		
72.	DD000000196879A		
73.	DD000000196977A		
74.	DD000000196982B		
75.	DD000000197227A		
76.	DD000000197272A		
77.	DD000000197284B		
78.	DD000000197425B		
79.	DD000000197433A		
80.	DD000000197592B		
81.	DD000000197628A		
82.	DD000000197640B		
83.	DD000000197661A		
84.	DD000000197837A		
85.	DD000000197853A		
86.	DD000000197886B		
87.	DD000000198050A		
88.	DD000000198106A		
89.	DD000000198186A		
90.	DD000000198353A		
91.	DD000000198361A		
92.	DD000000198743A		
93.	DD000000199049A		
94.	DD000000199089A		
95.	DD000000199224A		
96.	DD000000199287A		
97.	DD000000199346A		
98.	DD000000199349B		
99.	DD000000199397A		
100.	DD000000199495A		
101.	DD000000199596A		
102.	DD000000199647B		
103.	DD000000199986B		

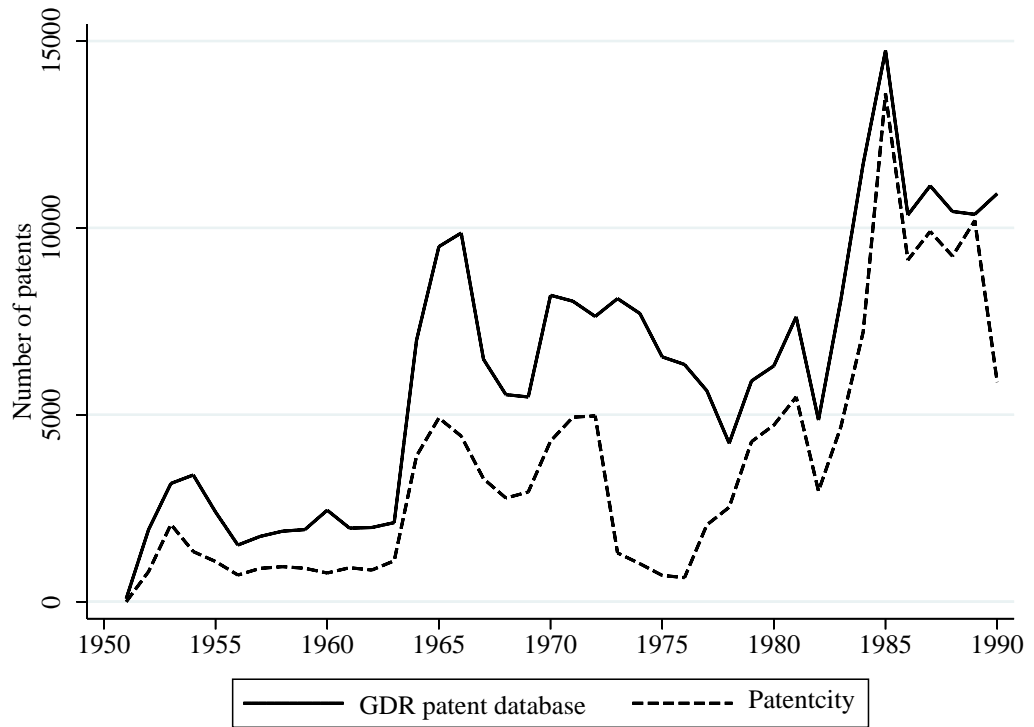

Figure A1: Granted patents in the GDR according to the publication date in the Comprehensive GDR Patent Database and in Patentcity

Note: The Figure depicts only the patents with the data of publication between 1950-1990. 16,455 patents contained in the GDR patent database with the publication data after 1991 are excluded from the graph.

IMPRESSUM

Jena Economic Research Papers

ISSN 1864-7057

Friedrich Schiller University Jena

Faculty of Economics and Business Administration

Carl-Zeiss-Str. 3

D-07743 Jena, Germany

Email: office.jerp@uni-jena.de

Editor: Silke Übelmesser

Website: www.wiwi.uni-jena.de/en/jerp

© by the author